

Service Manual

Hi-Fi Speaker System

Surround Speaker
SB-PS570

Colour

(K).....Black Type



■ SPECIFICATIONS

Type	1-way 1-speaker system
Speakers	Full Range: 8 cm cone type
Impedance	4 Ω
Input Power	50 W, Music 25 W, DIN
Output Sound Pressure Level	82 dB/W (1,0 m)
Frequency Range	110 Hz \approx 22 kHz (-16 dB)
Dimensions (W x H x D)	110 x 141 x 125 mm
Weight	0,5 kg

Note:

Design and specifications are subject to change without notice.

■ ESPECIFICACIONES

Tipo	Sistema de 1 vía y 1 altavoz
Altavoces	Rango completo: tipo cónico de 8 cm
Impedancia	4 Ω
Capacidad de potencia	50 W, Música 25 W, DIN
Nivel de presión acústica de salida	82 dB/W (1,0 m)
Respuesta de frecuencias	110 Hz \approx 22 kHz (-16 dB)
Dimensiones (W x H x D)	110 x 141 x 125 mm
Peso	0,5 kg

Nota:

Estas especificaciones están sujetas a cualquier cambio sin previo aviso.

■ SPECIFICATIONS

Type	1-voies 1-haut-parleurs
Haut-parleurs	Gamme intégrale: 8 cm type a cone
Impédance	4 Ω
Entrée maximale	50 W, Musique 25 W, DIN
Niveau de pression sonore de sortie	82 dB/W (1,0 m)
Gamme de fréquences	110 Hz \approx 22 kHz (-16 dB)
Dimensions (W x H x D)	110 x 141 x 125 mm
Poids	0,5 kg

Note:

Subject à changement sans preavis.

■ SCHEMATIC DIAGRAM

(This schematic diagram may be modified at any time with development of new technology.)

(Este esquema puede ser modificado en cualquier momento con el desarrollo de nuevas tecnologías.)

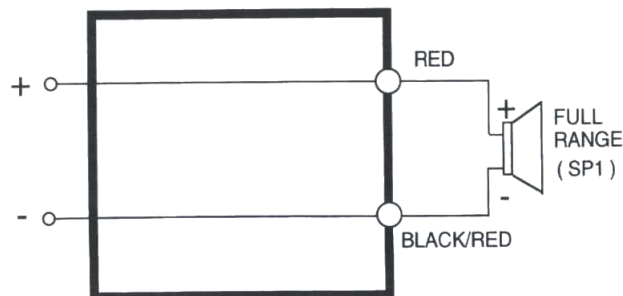



⚠ WARNING

This service information is designed for experienced repair technicians only and is not designed for use by the general public. It does not contain warnings or cautions to advise non technical individuals of potential dangers in attempting to service product. Products powered by electricity should be serviced or repaired only by experienced professional technicians. Any attempt to service or repair the product or products dealt with in this service information by anyone else could result in serious injury or death.

Technics®

© 1996 Panasonic Spain S.A.
All rights reserved. Unauthorized copying
and distribution is a violation of law.

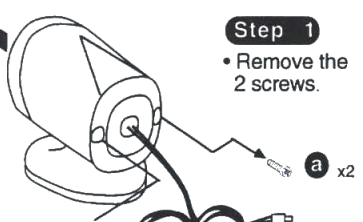
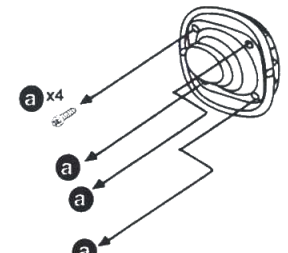
DISASSEMBLY INSTRUCTIONS

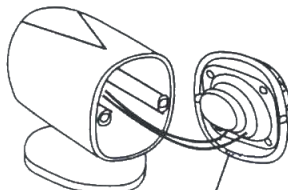
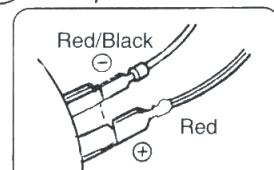
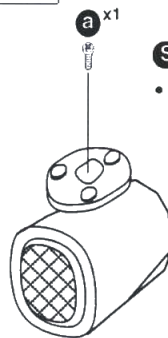
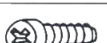
Ref. No. 1	Removal of the Front Ring Ass'y	Ref. No. 3	Removal of the Speaker Surround
Procededure 1		Procededure 1 → 2 → 3	
<p>Step 2</p> <ul style="list-style-type: none"> Remove the Front Ring Ass'y in the direction of arrow. 	<p>Step 1</p> <ul style="list-style-type: none"> Remove the 2 screws. 	<p>Step 1</p> <ul style="list-style-type: none"> Remove the 4 screws. 	
 a Screw Ø 4,2 x 8 mm		 a Screw Ø 4,2 x 8 mm	
Ref. No. 2	Removal of the Speaker Terminal	Ref. No. 4	Removal of the Diagonal Stand Ass'y
Procededure 1 → 2		Procededure 4	
<p>Step 1</p> <ul style="list-style-type: none"> Remove the 2 Speaker Terminals.  		<p>Step 1</p> <ul style="list-style-type: none"> Remove the 1 screw. 	 a Screw Ø 4,2 x 8 mm

REPLACEMENT PARTS LIST

- Notes 1. Part numbers are indicated on most mechanical parts. Please use this part number for parts orders.
 2. [PAES] indicates parts that are supplied by PAES.
- Notas 1. El código está indicado en la mayoría de las piezas. Por favor, use este código para sus pedidos.
 2. La indicación [PAES] significa recambios suministrados a través de PAES.

Ref. No.	Part No.	Part Name & Description	Remarks
		SPEAKER (S)	
SP1	EAS8P335A6	SPEAKER (FULL RANGE)	[PAES]
		CABINET PARTS	
1	RGSPS730	FRONT RING ASS'Y	[PAES]
2	RGPP0436B-K	CAVITY	[PAES]
3	RGQP0149E-1K	BASE	[PAES]
4	REXPPS570	SPEAKER CORD ASS'Y	[PAES]
5	RKA8G0066-K	LEG	[PAES]
		SCREW (S)	
N1	XTBS42BZ+8	SCREW	[PAES]

EXPLODED VIEW

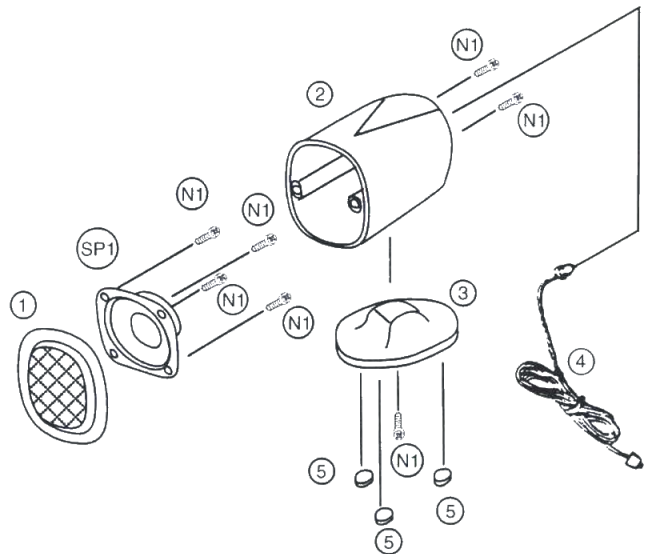

PACKAGING

NOTE: For packaging as sistem work, please refer to SB-PT570 (ORDER NO. PAAU960392C6)

[PAES] Printed in Spain
A960309000JS